

Next Generation Vehicle: Stainless Steels for automotive lightweight applications

Initiated in 2004 and concluded in 2009, a consortium of stainless steel producers together with leading automotive OEMs and other industrial partners investigated the potential of stainless steel in the design and manufacture of passenger cars.

Project Partners:

1. Stainless Steel Manufacturers:
 - a. ArcelorMittal Stainless Europe
 - b. Outokumpu Oyj
 - c. ThyssenKrupp Nirosta GmbH
2. Automotive Manufacturers:
 - a. AUDI AG
 - b. Bayerische Motoren Werke AG
 - c. Centro Ricerche Fiat
 - d. Daimler AG
 - e. GM/Saab Automobile AB
 - f. Volvo Car Corporation
3. CAE-Providers:
 - a. ALTAIR Development France
 - b. AutoForm GmbH
 - c. Engineering Research Nordic AB
 - d. ESI Group.
4. Industrial Partners:
 - a. AP&T AB
 - b. BASF Coating AG
 - c. Uddeholm Tooling AB
5. Research Partner
 - a. Camanoe Associates

To find out more about the results of this initiative, please consult the following publications:

1. Press release and clippings
 - a. [Light and safe: stainless steel producers show the future of the car – “Next Generation Vehicle” project presents study on use of new materials in automotive construction](#) (Press release by the consortium 12 September 2007)
 - b. [“Stainless steel car frames – The next generation”](#), Nickel, Vol. 24, No. 1, December 2008
 - c. GEHM, R., [“A Stainless future”](#), aei-online, June 2009
 - d. [“Next Generation Vehicle - Stainless steel in structural automotive applications”](#), Stainless Steel Focus 10/2009

2. Technical and scientific papers

- a. SCHUBERTH, S. / SCHEDIN, E. / FRÖHLICH, Th. / RATTE, E., “[Next Generation Vehicle – Engineering guidelines for stainless steel in automotive applications](#)”, Proceedings of the 6th Stainless Steel Science and Market Conference, Helsinki (Finland), 10 – 13 June, 2008
- b. SCHEDIN, E. / JANSSON, M. / GROTH, H. L. / SANATACREU, P.-O. / RATTE, E., “[Design of a stainless B-pillar – a concept evaluation using finite element simulation](#)”, Proceedings of the International Deep Drawing Research Group (IDDRG) 2008 International Conference, Olofström, Sweden , 16 – 18 June 2008

Light and safe: Stainless steel producers show the future of the car – “Next Generation Vehicle” project presents study on use of new materials in automotive construction

Using stainless steel in automotive construction can save weight and thus conserve resources without compromising safety standards. Light and safe are not mutually exclusive, and stainless steel can deliver solutions to meet rising environmental standards. That is the conclusion reached by the “Next Generation Vehicle” project, an alliance of leading stainless steel producers and automotive OEMs. The international research group is presenting its study today in Frankfurt am Main at the IAA, the world’s biggest motor show.

The project was launched at the end of 2004 with the aim of identifying potential for the use of stainless steel in auto construction. As part of the study, innovative materials were developed and tested for new applications – with groundbreaking findings. The automotive OEMs participating in the project were Audi, BMW, DaimlerChrysler, Fiat, General Motors/Saab and Ford/Volvo, while the stainless steel producers involved were ThyssenKrupp Nirosta (Germany), Outokumpu (Finland) and ArcelorMittal Stainless (France). “The challenge facing the project was to reconcile ecologically driven demands for lower weight with increasing safety standards,” said Dr. Alfred Otto, Chief Sales Officer at ThyssenKrupp Nirosta. “Our studies show that stainless steel offers solutions for the car of the future. We supply technologically mature and innovative stainless materials capable of meeting the high requirements involved,” he continued. “Using these tailored materials, automotive OEMs can produce vehicles which come closer to the important general aim of protecting the environment.”

The study, drawn up by development and applications engineers from the companies involved, shows that the use of stainless steel in vehicle construction can be especially beneficial in crash-relevant structural parts. The major advantages of stainless steels, such as high strength and weight reduction, make their extensive use both practical and expedient in resource-conserving auto production.

The aim of the “Next Generation Vehicle” project is to draw up processing guidelines for stainless steels as a prerequisite for their use. This was done with reference to B-pillars which were tested in crash simulations. The results were verified in collaboration with leading suppliers of simulation programs for metal forming which allow the crash performance of stainless steel to be simulated. These programs were developed further as part of the “Next Generation Vehicle” project. The project’s findings have been summarized in design and processing guidelines. The new software programs, which will also be available commercially in the future, meet a further requirement for the broader use of stainless steel. They open up new possibilities for automotive developers. The “Next Generation Vehicle” project also developed a cost model in collaboration with the Boston MIT (Massachusetts Institute of Technology) which allows the use of different production methods and materials to be compared directly and the optimum stainless steel solution determined. “Next Generation Vehicle” will continue its work in the coming months.

Stainless steel already offers attractive possibilities to automotive development engineers. For example, specially developed materials from ThyssenKrupp Nirosta are already being used in auto construction to make crash components for the Porsche Carrera GT, roll bars for the Porsche Boxster, components for the Audi A6 and frame structures for the Audi A8. In some areas, this is already leading to a reduction in parts count and costs.

For more information go to www.ngvproject.org.

Stainless Steel Car Frames: The Next Generation

Austenitic stainless steels reduce the weight of individual components by about 20 percent

“Any customer can have a car painted any colour that he wants,” automotive pioneer Henry Ford once famously quipped. “— so long as it is black.”

Likewise, today’s vehicle manufacturers could be soon producing cars and trucks with any frame the customer wants, so long as it contains plenty of stainless steel.

A consortium of European carmakers and stainless steel manufacturers has spent three years testing stainless steels for use in door pillars and other structural components of vehicle frame. The results show that stainless — particularly nickel-containing-austenitic grades which gain strength as they are formed or deformed — can replace carbon steel, saving weight without compromising the properties needed to protect occupants in a crash.

With gasoline prices on a roller coaster ride and demand growing for hybrid and fuel-efficient vehicles that cut greenhouse gas emissions, North American carmakers appear eager to change course.

“Weight costs money, it costs efficiency, and it costs fuel; it’s as simple as that,” says Roland Gustafsson, manager of the consortium’s research project known as Next Generation Vehicle (NGV). “Every kilo you can lose results in savings over the life of the car. When you have lower weight, you can redesign other systems in the car. It’s a beneficial spiral: you can reduce the engine size, you can reduce the gearbox.”

The NGV project was launched in 2005 by nine companies that provided research and test facilities and brought together more than 150 engineers, scientists and software developers to explore ways to add stainless components to cars. Audi, BMW, Fiat, DaimlerChrysler, Saab Automobiles and Volvo Car joined forces with Outokumpu, ThyssenKrupp and ArcelorMittal Stainless Europe (Ugine & ALZ). The partners

have so far invested 5 million euros in the project, on top of donating research time and facilities, says Gustafsson.

The results of the program were unveiled in late 2007 at the International Motor Show convention in Frankfurt, Germany. Four grades of stainless were tested to determine their suitability in carmaking based on mechanical properties, corrosion resistance, and their ability to be formed, machined and joined to other materials. Three were austenitic steels: 1.4376 (S20100), 1.4318 (S30153) and 1.4310 (S30100); the fourth, 1.4162 (S32101), was a duplex.



“The goal was to show the world it’s possible to use stainless steel for this type of application,” notes Eric Sörqvist, manager of research and development for Outokumpu Automotive, a division of Finnish stainless steel producer Outokumpu. Results for all four grades were excellent.

“The stainless steel lends itself well to making complicated components or components that require high localized strength levels,” he says. “We know stainless steel can’t replace all materials, but in certain spots and in certain applications, yes, there are advantages.”

One major advantage is weight. The NGV project confirmed that replacing sections

of vehicle frames with stainless can trim as much as 20 per cent off the weight of the component. Gustafsson, whose full-time position is head of Volvo Technology Corporation in Gothenburg, Sweden, says it’s crucial that there be compensation for all the additional weight coming in with the next generation of vehicles. As the industry switches to building hybrid cars the weight savings achieved with stainless compensates for the added weight of the electric motor and batteries that provide the second power source.

The austenitic grades, in particular, are well-suited to car manufacturing. They become stronger as they are hydro-formed or cold-rolled into the shape of components, and this strength is necessary to meet crash-safety standards. As well, the production processes create less scrap, saving material and reducing costs.

The NGV project showed that stainless can be welded to the carbon steels now used in car frames; as a result, carmakers can continue to use traditional metals while adding stainless where it works best. The grades tested are readily joinable with basically all other types of steels, says Sörqvist, adding that adhesives and waxes are used to prevent corrosion from developing at the joints.

Project engineers used nickel-containing stainless steel to build parts of a door post (known as a B-pillar) for a Volvo S40, confirming that the material can be formed and joined with conventional steels and is capable of withstanding crash testing. But Sörqvist says the project’s most remarkable breakthrough may be the development of software programs that simulate all stages of production, taking metal through each step of forming and welding. The programs enable engineers to see how substituting grades and fabrication processes can improve the finished part.

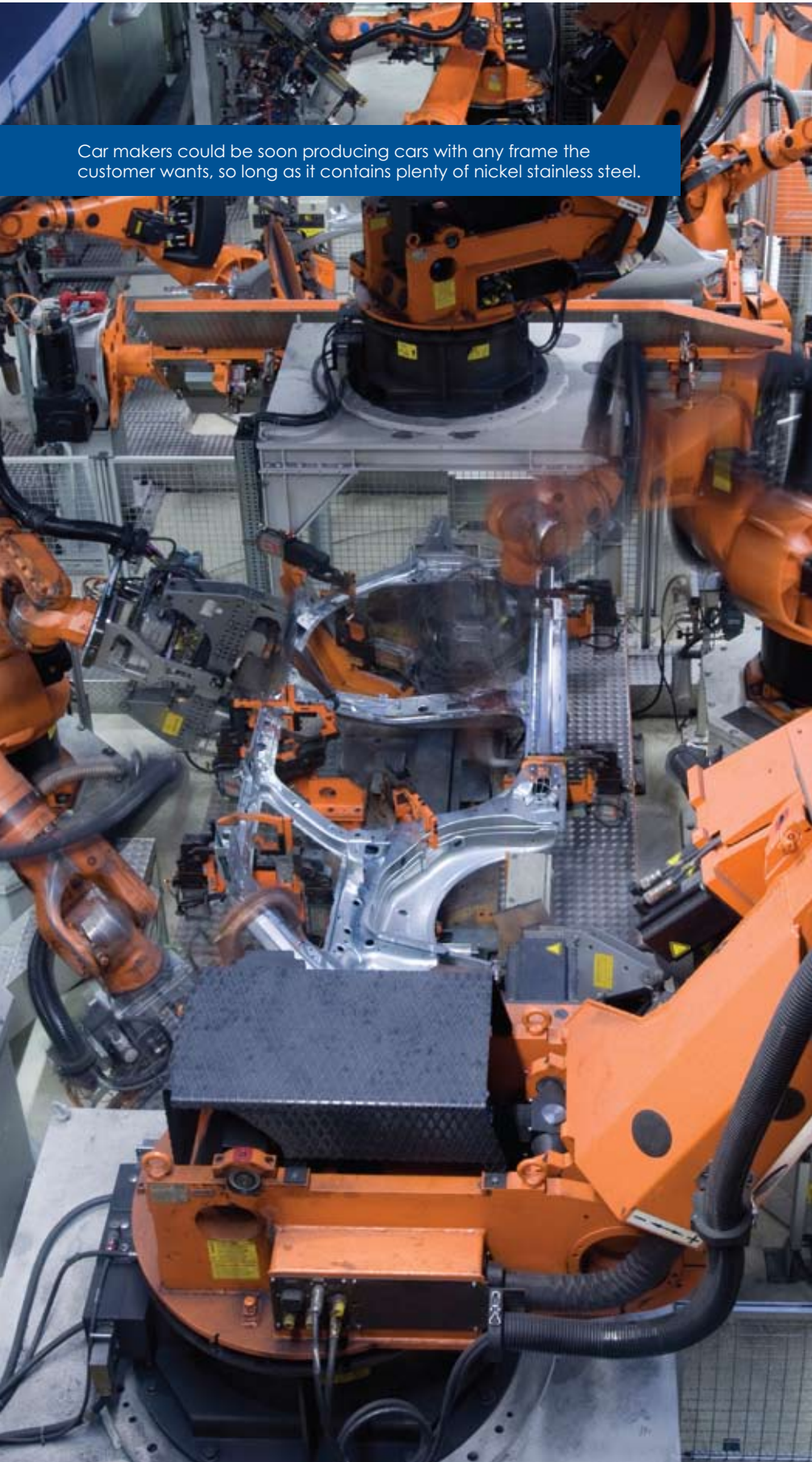

Car makers could be soon producing cars with any frame the customer wants, so long as it contains plenty of nickel stainless steel.

“Without the software, it wasn’t really possible to simulate this in a proper way, taking into consideration the deformation hardening and the way that happens,” he says. “It’s a big step forward,” enabling carmakers and other manufacturers to determine the best materials and applications without having to build and test parts that won’t make the grade. “It’s important for the use of austenitic materials in any kind of application.”

As for automobiles, both Sörqvist and Gustafsson say the lighter weight of stainless steels and the fact that austenitic grades can be made stronger during forming mean it is now possible to design vehicles from the ground up, as it were.

**“Weight costs money.
It costs efficiency, and
it cost fuel;
it is as simple as that”**

The next stage is to produce a prototype of a complete vehicle frame using stainless steel components. Toward that end, the NGV project is seeking North American carmakers as partners. Gustafsson says General Motors, which is struggling to cope with the global economic crisis and increased demand for fuel-efficient vehicles, has expressed interest.

“Our goal is to expand the Next Generation Vehicle project to North America,” he adds. “I would love to be at the Detroit Motor Show in 2010 to show a complete vehicle structure made of these materials.”

MORE INFORMATION:
www.nickelmagazine.org/nextgeneration

A stainless future

A push is under way to move stainless steel into more vehicle applications than just exhaust systems—notably structural parts and fuel cells.

by Ryan Gehm

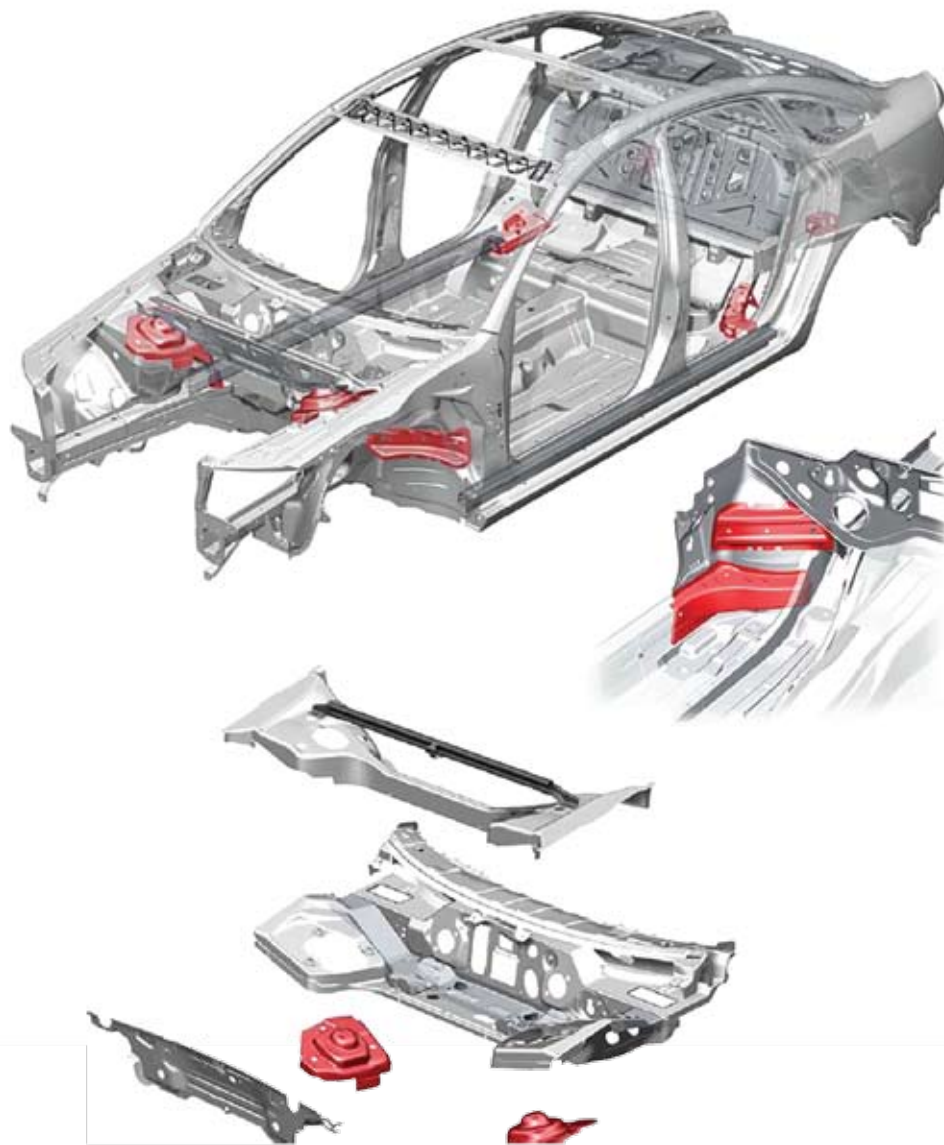

Eight highly stressed components in the body structure of the Audi A6 are made of Nirosta H400 ultrahigh-strength austenitic stainless steel (shown in red) from ThyssenKrupp Nirosta. (Audi)

No, the automotive industry is not going *Back to the Future*. So don't expect any vehicles with exposed stainless steel (SS) body panels and gull-wing doors—*à la* the **DeLorean** DMC-12 of the early '80s—in mass production any time soon.

Even so, industry experts such as Tom Long, Manager of Specialty Steel Sales for Ohio-based **AK Steel**, do expect the percentage of the corrosion-resistant material within each vehicle to increase in coming years. Unlike in the past decade, when much of the growth resulted from its traditional role in the exhaust system, as dual exhausts became more popular and vehicle sizes swelled, future growth is likely to come from its use in non-exhaust applications as well.

Stainless trim on vehicles has picked up slightly, according to Long, and it's being used more in fuel systems and fuel filler necks as well as in superchargers and turbochargers for manifolds, for example.

Such high-heat applications call for higher alloys of SS, he explained: "Instead of 409, they use the high-chromium versions of stainless steels, 15 to 18% chromium alloys" versus a minimum of about 11%.

But perhaps the most promising area for SS is in structural parts, though some people, as Long suggests, still see that "as mainly drawing board-type material right now."

Moving those applications from the drawing board to "on board" was the mission of the Next Generation Vehicle (NGV) Project, conducted by a large group of mostly European automakers, steelmakers, CAE providers, and industrial partners. The joint research project, which attempted to determine how and where stainless could be placed in a body-in-white (BIW), just concluded at the end of April, and partners are now pursuing their respective production avenues.

The light material

So just where is stainless steel suitable in a BIW? "Everything that is crash-relevant" is fair game, replied Stefan Schuberth, Senior Manager, Application Development, **ThyssenKrupp Nirosta** GmbH, a NGV participant. He believes that, realistically, a BIW could consist of 20 to 40 lb (9 to 18 kg) of stainless.

"It could be much more, of course; it could be 100 lb or more, but it only really makes sense wherever you have all the benefits from stainless at the same time because of the material prices," Schuberth explained. SS reportedly can be about two-

and-a-half to three times more expensive than carbon steel.

Laying out the benefits of stainless beyond heat and corrosion resistance, Pierre-Olivier Santacreu, Section Manager for Stainless Steel Solutions, Research & Development, ArcelorMittal Isbergues, said, "We are thinking about BIW parts which could not be reached today by advanced high-strength steel in terms of forming capability and/or strength and energy absorption."

Those components include A- and B-pillar reinforcement parts, bumper beams, rollover bars, crash boxes, suspension/wheel housings, and subframes.

"The idea is not to have a complete stainless steel BIW but to implement relatively small parts inside it, leading to a significant weight savings—about 30%—and safety improvement with no or low over-cost in terms of \$/kg gained," Santacreu added.

Exactly how far the material will reach—the full structure or just part of it—is a matter of optimization, according to the Program Director of the NGV Project, Roland Gustafsson. "It depends on the type of vehicle you look at, what type of volumes we're talking about, and which kind of requirements we have."

Despite any cost penalty with stainless steel (Gustafsson claims that SS is cost-competitive with boron steel), the ability to reduce component weight could be compelling enough a reason to make the switch.

"I see a huge potential for applying this technology to compensate for all the added weight due to future hybrid drivetrains and alternative-fueled cars [or] whatever's in the pipeline," he said.

Considering just the structural parts of an average European vehicle, SS could reduce mass in the range of 90 to 110 kg (200 to 245 lb) by replacing today's conventional mixture of steel grades, according to Gustafsson. "I presume that we can gain perhaps even more on the typical American car" due to its larger size.

Making it to market

As with many other advanced technologies on their journey from promising low-volume application to high-volume ubiquity, SS structures will enter the market through the premium segment before trickling down to more mainstream vehicles, Gustafsson said.

This process has already been set in motion by German carmakers **Audi** and **Porsche**. For example, the Porsche Carrera GT features energy-absorbing crash components made from Nirossta H400 austenitic SS in both the front and back areas. Other car manufacturers are interested, too, said Schuberth.

"Austenitic [stainless steel] has a very good material behavior when it comes to a crash because its structure can change to very high strength while being crushed," he explained. "This helps us a lot against competitive materials, especially aluminum alloys."

The material's high formability enables the integration of several parts into one, Schuberth noted, which can reduce tooling costs. "We have elongation values around 60%; usu-

For the future, we are convinced that the stainless solution could offer a real breakthrough in terms of lightweight design.

—Pierre-Olivier Santacreu, ArcelorMittal



This hydroformed connecting node for an A-Pillar illustrates the high formability of stainless steels. (The original tube was rounded and straight.)

ally you can only receive this with deep-drawing steel."

C700-800 strength class grades with about 45 to 50% elongation are well adapted for complex geometry and hydroformed parts, Santacreu said.

"Corrosion resistance is not very useful in a BIW part because the part is submitted to ED [electrodepositing] coating," he added. "But in some class of external side panel or roof member, it could be of real interest adding an aesthetic value."

Though some issues—such as a lack of experience with forming and assembling with other materials, as well as design rules concerning stainless steels—have been largely overcome through projects like NGV, challenges still remain in bringing SS structures to the mainstream. Chief among those is cost.

"The cost-effectiveness of the stainless solution had to be proven," said Santacreu. "We now use an adapted cost model taking account of some of the specificities in the manufacturing, also including new forming technologies like hydro-



A B-pillar made of carbon steel DP600 and stainless steel C1000 was validated in a crash test during the NGV Project. The tailored laser-welded blank has a tensile strength of greater than 1000 MPa (145 ksi).



Fuel cells offer opportunity for stainless

Both proton exchange membrane (PEM) and solid-oxide fuel cell (SOFC) types present new opportunities for stainless steel (SS)—for example in heat exchangers, humidifiers, combustors, and plates.

“All of those different components could be made up of metallic materials, and very often stainless steel represents the best optimal point between costs and performance,” said Scott Weil, a staff scientist with expertise in materials science and metallurgy at the **Pacific Northwest National Laboratory**, which has worked with companies (such as **Delphi** on its SOFC) to overcome issues on a technology’s path to production.

A SOFC stack consists of two major components: the membrane, which usually is made of a ceramic, and an interconnect plate, which serves to connect one membrane to another electrically.

“When the electrochemical reaction occurs you get as a by-product water,” Weil explained. “So that’s another thing you have to be concerned about is what’s the durability of the metal under those conditions—high-temperature air, high-temperature hydrogen, and a humid environment. Many stainless steels are very oxidation-resistant; that’s one of the big pluses.”

Another “big plus” with certain stainless steels, according to Weil, is that they offer good thermal-expansion matching with the ceramic material. “If you pick a metal that expands at a very high rate, you’ll have a chance of cracking your ceramic membranes.” In particular, the 400 series ferritic stainless steels work well in this role: “The austenitics are not as good a match,” he said.

Though stainless is the leading candidate for that SOFC plate application (nickel-based alloys and electrically conductive ceramic plates with perovskite materials have also been considered), it is not without its issues, Weil noted.

While SS is generally very oxidation-resistant, that resistance may not be sufficient by itself in the long term—after tens of thou-

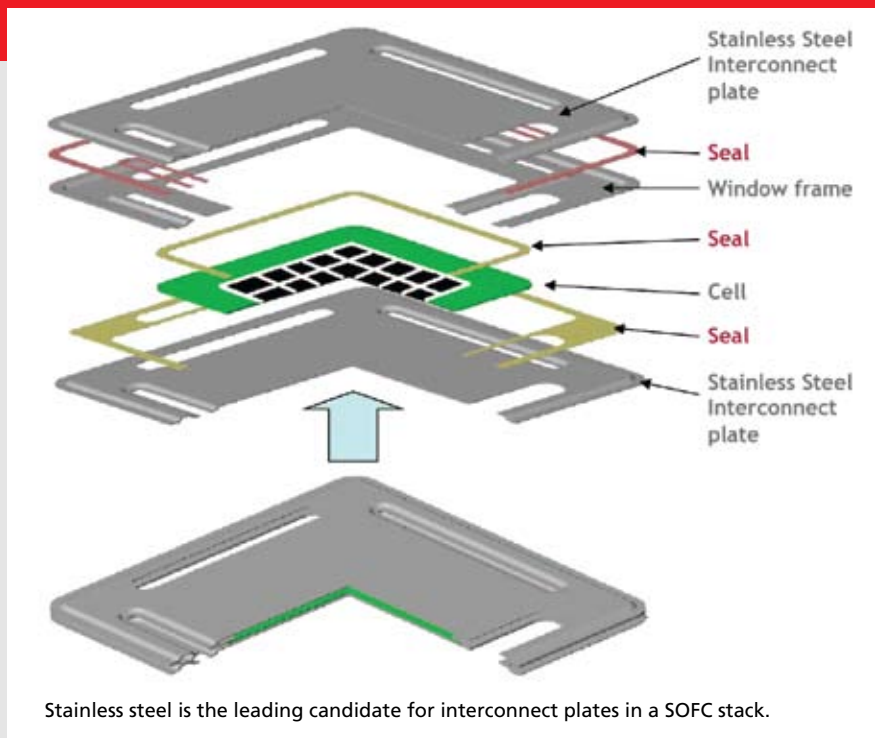

Stainless steel is the leading candidate for interconnect plates in a SOFC stack.

Pacific Northwest National Laboratory

sands of hours of use. “And [stainless] may not be as electrically conductive as you would like out at the long term as well,” he added. “So people have been looking at not necessarily replacing the stainless steel, but how to modify it to make it work better in that environment.”

One way, he noted, is by applying conductive oxide coatings such as manganese cobaltite, which can be sprayed and sintered onto the surface of the SS to form a tight, adherent layer.

The greatest competition among materials, according to Weil, is in the PEM fuel cell for the bipolar plate, which has typically been made of graphite because it’s very corrosion-resistant and electrically conductive.

“The problem is that graphite is brittle, so it’s not something you necessarily want to put in a device that’s in a transportation vehicle,” he said, adding that graphite is also expensive, not to mention time-consuming and costly to machine

for channels that transport water and gas.

Alternative materials considered include carbon composites, conductive polymers, and various metals such as nickel, titanium, and both austenitic and ferritic SS. “Each of those materials has its pluses and minuses,” said Weil. “Stainless steel is certainly in the running, again because it’s probably the lowest-cost material that you can consider for that application, because you can make it very thin, and because you can manufacture it by stamping or by coining processes to get those gas passages built into it; you don’t have to machine it. So it often offers lower-cost manufacturability.”

Stainless may also have an edge because automotive designers and manufacturers are already comfortable using steels. “They’ve used them for decades,” he said.

Ryan Gehm

forming and 3-D profiling. Some grades less sensible to the fluctuation of alloying elements (Ni) could also be promoted and proposed.

“We know that if you put a few stainless parts at good places in a BIW it is cost-effective, but also we need time for homologation of new grades in the auto industry.”

Though a bonus to using SS is that it could remain uncoated and unpainted, applying those processes to stainless is not as simple as with other materials. “We need to have a rougher surface [than] the regular surface for stainless steel,” said Schuberth. “So we need to do some extra [surface preparation] so that the coat sticks.”

“We have looked into all different sorts of pretreatment of stainless to allow for surface treatment or complete painting,” Gustafsson said. “So there are paint systems available from the paint suppliers that are fully adapted for stainless or even the more difficult mixed-materials situation where you’ll have stainless together with zinc-plated steel or with aluminum.”

Gustafsson predicts that at least another three or four years will pass before a vehicle with a structure consisting significantly of unpainted SS parts hits the market in either Europe or the U.S.

Just don’t expect it to be equipped with a flux capacitor, like that famous Hollywood-modified DeLorean. **aei**

Next generation vehicle

Stainless steel in structural automotive applications

When you think of stainless steel and the automotive sector, more likely than not it is exhaust systems that spring to mind. There are, of course, many other applications, such as stainless steel trim. And then, there are applications which may be rather less obvious - windscreen wipers, cylinder head gaskets, and fuel systems. New potential opportunities are opening up all the time, such as the use of stainless steel in fuel cells. However, one of the most

promising areas for stainless steel in the automotive sector would seem to be in structural applications. This explains the launch at the end of 2004 of the "Next Generation Vehicle" project. The aim of the project was to demonstrate to the automotive industry that stainless steel can be used to reduce weight and cost in the manufacture of motor vehicles, and at the same time improve safety and sustainability in automotive body structures. In view of the complexity of the topic, and the large experimental effort required, the project was organ-

ized jointly by the three European stainless steel producers ThyssenKrupp Nirosta GmbH, ArcelorMittal Stainless, and Outokumpu Oy. The European car manufacturers were represented by Audi AG, BMW AG, Daimler AG, Saab Automobile AB, Volvo Cars, and the Centro Ricerche Fiat. Four grades of stainless were used in the NGV project - three austenitic and one duplex. These were the austenitic grades 1.4376, 1.4318 (1.4318 C1000), and 1.4310 (1.4310 C1000), and the duplex grade 1.4162. These were tested to deter-

mine their suitability for use in carmaking from the point of view of mechanical properties, corrosion resistance, and their ability to be formed, machined, and joined to other materials. A key characteristic of the austenitic materials tested is their high work hardening rate. This means, on the one hand, that their strength increases as they are cold formed into the shape of the component by conventional or advanced forming methods like hydroforming. Significant reductions in weight can be achieved as a result. But there is a second advantage. The work hardening rate depends on the speed of deformation. In the event of a collision, the stainless steels investigated can absorb more energy than the usual structural steels. Stainless steel can not only help to reduce weight, but also to enhance passenger protection.

Cost is, of course, always a factor, and it is clear that in view of the higher cost of stainless steel, it is only really beneficial to use it where it works best. The "Next Generation Vehicle" project has de-



Crash Test Rig for Components

veloped a cost model which allows the use of different production methods and materials to be compared directly and the optimum stainless steel solution determined. The NGV project also clearly demonstrated that stainless steel can be welded with some adaptations to the carbon steels

mine their suitability for use in carmaking from the point of view of mechanical properties, corrosion resistance, and their ability to be formed, machined, and joined to other materials. A key characteristic of the austenitic materials tested is their high work hardening rate. This means, on the

veloped a cost model which allows the use of different production methods and materials to be compared directly and the optimum stainless steel solution determined. The NGV project also clearly demonstrated that stainless steel can be welded with some adaptations to the carbon steels

currently used in automotive production. This means that stainless steel can be used selectively in those parts where its properties are beneficial, but that carmakers can continue employing their traditional metals in other parts.

One of the key aims of the

hardening effect of metastable austenitic stainless steels. These advanced models and their simulation results were verified by designing, building and crashing different types of B-pillars (door pillars).

Beside the guidelines how to properly use stainless steel, the development of

build and test parts which ultimately prove to be unsuitable.

The NGV project's findings have been summarised in the paper "Next Generation Vehicle - Engineering Guidelines for stainless steel in automotive applications". The conclusions of this paper are as follows:

- Stainless steels show very good combinations of strength and ductility which is of special interest in automotive applications. The use of this material presupposes the safe and correct use in all stages of automotive development and production.
- In tooling and forming, stainless steels show the same restrictions as high-strength carbon steels. Special coatings are recommended in order to withstand the high forces and allow an accurate forming.
- Joining of stainless steel in uni-material and mixed joints is possible. In some cases, the parameters are different from those typical of carbon steels, but in general the range is not greater than for different grades of carbon steel.
- To ensure corrosion resistance of the joints, the seam can be protected by wax or by coatings which provide a cathodic protection.
- The implementation of the results into the design of several B-pillar concepts shows, on the one hand, the po-

tential for a further weight reduction and, on the other hand, the cost efficiency of some concepts.

New growth through structural applications

The significant growth rates in stainless steel consumption experienced over the past many years were attributable in particular to its corrosion resistance, aesthetic appeal, and hygienic properties. It has already become clear that stainless steel is increasingly being applied in many areas for its mechanical properties such as a combination of very high strength and excellent formability, together with high energy absorption properties. These properties are particularly applicable to the automotive sector, where they can lead to significant weight savings and, at the same time, to safety improvements.

The "Next Generation Vehicle" project has demonstrated this to the automotive industry, and the use of stainless steel in structural applications in this sector looks set to take off. The NGV consortium has now concluded its work. The stainless steel story has been taken to a point where it is maturing inside the OEMs. The NGV findings may have come at a good moment in time. As demonstrated at the recent Frankfurt Motor Show, electrically driven and hybrid cars are becoming a top priority, and in these cars weight reduction is more important than ever.



"Next Generation Vehicle" project was to draw up processing guidelines for stainless steel as a prerequisite for its use. Beyond that the available software programs for metal forming were optimised in collaboration with the leading suppliers of simulation programs by taking into account the special work

software programs which simulate forming and crash behaviour and the specific cost model for all stages of production are considered to be a major breakthrough. It allows engineers to see how different grades and fabrication processes can improve the finished product, and avoids the need to

Next Generation Vehicle – Engineering Guidelines for stainless steel in automotive applications

S. Schubert¹, E. Schedin², Th. Fröhlich³, E. Ratte¹

¹ThyssenKrupp Nirosta GmbH, Krefeld, Germany

²Outokumpu Stainless AB, Avesta, Sweden

³ArcelorMittal Stainless Europe, Isbergues, France

Abstract

The objectives of the NGV (Next Generation Vehicle) Project were to demonstrate that stainless steel can be used to reduce weight and costs, and to improve safety and sustainability in structural automotive systems. The deliverables include enabling technologies, virtual technology for design and development, processing and testing. The compilation of the results as well as aspects such as new design criteria for the application of stainless steels in automotive components were arranged in an Engineering Guideline for car manufacturers and their suppliers. The program was approved by constructing several newly designed B-pillars where the deliverables were successfully applied. After performing some regular crash tests the cost efficiency was estimated by the NGV cost model. The NGV Project deliverables and data base establish a sound basis for the use of stainless steels in automotive series production.

Introduction

The automotive industry of today is characterized by faster cycles in materials invention, development and application, coupled with the ability to tailor materials for specific end-users requirements i.e. multi material solutions. It is therefore essential for materials development to be closely integrated with the final product and process concurrent engineering practice. This means being aware of

- the market and customers,
- industrial and environmental trends and forces,
- recycling,
- cost efficiency,
- and technology development.

The aim of the project is to point out to the automotive industry that stainless steel can be used to reduce weight and cost in the manufacture of motor vehicles and to improve safety and sustainability in automotive body structures. The competitiveness of stainless steels should be approved in the same process steps which a standard automotive development follows: the virtual development supported by FE-simulations, the analysis of forming, tooling, joining and determination of surface and corrosion properties. These different areas mark the structure of the NGV Project. The material choice for the project and the main results of the different research areas are explained in the following.

Because of the complexity of the topic and the large experimental effort the project was organised by the three stainless steel producers ThyssenKrupp Nirosta GmbH, ArcelorMittal Stainless and Outokumpu Oyj. The European car manufacturers were represented by AUDI AG,

BMW AG, Daimler AG, Saab Automobile AB, Volvo Cars and the Centro Ricerche Fiat. For the different working groups experts were integrated to ensure that the experiments conducted are according to the current state of the art.

Material

Traditionally, stainless steels are classified mainly by their microstructure. The major basic groups are martensitic, ferritic, austenitic and duplex (austenitic & ferritic) materials. The area of use for stainless steels is very vast and comprises mainly applications taking advantage of properties such as resistance against corrosion and/or very high or low temperatures as well as hygienic surfaces and aesthetic appearance. Increasingly, stainless steels are being used also for their mechanical properties such as the combination of very high strength and excellent formability together with high energy absorption capability in finished components. The stainless steels used in the NGV Project are all but one austenitic and that one is duplex, **Table 1**. The chemical composition of the different grades is given in **Table 2**.

Table 1: Material selection for the NGV Project

EN	Type	Finishing	Supplier
1.4376	Austenitic	2B ¹	ThyssenKrupp Nirosta (TKN) ArcelorMittal Stainless Europe (AMSE) Outokumpu (OS)
1.4318 1.4318 C1000	Austenitic	2B ¹ Temper C1000 ²	
1.4310 1.4310 C1000	Austenitic	2B ¹ Temper C1000 ¹	
1.4162	Duplex	2E ³	

¹ Cold rolled, annealed to retrieve material properties after cold rolling, pickled and skin passed

² Reduced by cold rolling and achieved desired mechanical properties maintained, C1000 stating the tensile strength

³ Cold rolled, heat treated, mechanically descaled and pickled

Table 2: Chemical composition of materials investigated

Grade	C	N	Cr	Ni	Mo	Mn
1.4376	0.03	0.19	17.6	4.2	0.15	6.5
1.4318	0.025	0.11	17.5	6.6	0.20	<1.3
1.4310	0.10	0.03	17.0	7.0	<0.6	<2.0
1.4162	0.03	0.22	21.5	1.5	0.30	5.0

The austenitic materials referred to in these Guide Lines have mostly a more or less pronounced unique feature and that is deformation- or strain-induced hardening through a forming of martensite in the material. Thus facilitating cold rolling to very high strength levels or creating strength during forming operations.

Mechanical properties

Tensile tests on stainless steels are done according to EN 10002 standard, i.e. specimen geometry and preparation, test conditions (position relatively to the rolling direction, temperature indicated, etc). Tests are typically performed at room temperature (296 K), on as-received material in the three directions (0°, 90° and 45°). The mechanical properties and r-values are summarized in **Table 3**. The n-value is generally determined according to the standard above mentioned; computed between 18-40% for annealed grades and between 5-17% for temper rolled C1000 grades. Even if n-values are available, they are not very meaningful when considering austenitic stainless steels prone to deformation martensite formation since they do

not describe the complete curve. **Figure 1** shows such an example in the case of 1.4318 where the Hollomon model cannot fit the tensile curve because of two slopes due to the TRIP effect.

Table 3: Mechanical Properties (non-isothermal test conditions)

Value (unit)	1.4376	1.4318	1.4318 C1000	1.4310	1.4310 C1000	1.4162
R_{p0.2} (MPa)	410	420	800	300	950	600
R_m (MPa)	740	765	1050	800	1050	840
A₈₀ (%)	40	35	18	45	25	30
R₀	0,83	0,89	0,61	0,97	0,97	0,68
R₄₅	0,96	0,98	0,62	0,97	0,97	0,65
R₉₀	0,88	0,92	0,80	0,96	0,96	0,82

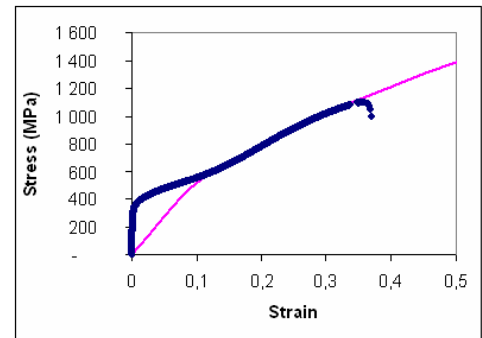

Figure 1: Comparison between the Hollomon model and the tensile curve for 1.4318

The materials here described are however not only prone to hardening through phase transformation but the rate of transformation is also dependent on strain rate as well as temperature. Consequently data from different temperature histories are of importance for forming simulation and for softwares to be able to handle those parameters. Additional to the standard tensile testing non-isothermal tests and isothermal tensile tests were conducted to determine the parameters necessary to fit the models describing the martensite formation.

Additional to the quasistatic tensile tests, dynamic material properties were investigated according to the PUD-S (Prüf- und Dokumentationsrichtlinie now SEP 1240 [3]). The dynamic material properties are measured in high speed tension tests at 1, 10, 100 and 250 s⁻¹.

For a complete material description in FE-simulation the knowledge about a suitable failure criteria is necessary. The most common experimental technique is the Nakajima method. Test specimens and conditions follow generally the PUD-S. Some differences or adaptations particular for stainless steels can occur in specimen geometry (not parallel length for sample) stamp diameters (100mm is standard for thick and temper 50 or 75 mm can be used) or in multilayer lubrication system.

The material properties are completed by fatigue tests. Wöhler curves (high cycle fatigue data), Manson-Coffin curves (low cycle fatigue) and cyclic hardening data are available on some NGV grades.

Simulation

Development of Input-data

The occurring TRIP-effect has a great impact of the forming behaviour and the resulting strength. Consequently the material models which are implemented into the FE-code have to consider the martensite formation and the resulting hardening. Additionally, it needs to provide a forming history containing information about the resulting strength distribution and thereby facilitating a correct base for crash simulation.

Two different material models, both considering the TRIP-effect and its temperature sensitivity, have been used for the project. The first model is the Hänsel-Model [1]. For the implementation two minor additions were made which avoid on the one hand that the hardening modulus will approach infinity as the plastic strain reaches zero and on the other hand the initially used yield surface according to von Mises was replaced by that of Barlat and Lian. The second model used is the Guimares model [2]. One major difference between the models is the different number of

parameters which is 13 for the Hänsel model and 4 for the Guimares model. The resulting material behaviour was implemented with a simple mix-law.

The failure prediction in FE-simulations is usually done by comparing the strain distribution in critical areas with experimental FLC. Following the discussion above the best would be to use a range of FLC, determined at different temperatures. Until such data are available or a better solution exists, i.e. the numerical determination of forming limits, it is recommended to use the FLC at room temperature as the best approximation.

After the validation of the above mentioned input-data (Figure 2 shows a deep drawn component with calculated martensite fraction), a B-pillar reinforcement was simulated using the modified Hänsel model. The crash simulation was validated with two different components: a rectangular tube was crashed in compression comparable to those crash boxes which are placed behind the bumper of a car. The second validation was done with a 3-point bending geometry (Figure 3) which was chosen because it has the same crash mode as a B-pillar which is bending. Both tests were simulated and compared to the experimental results. The prediction of forces could be improved by using the modified Hänsel model in forming and crash simulation [1].

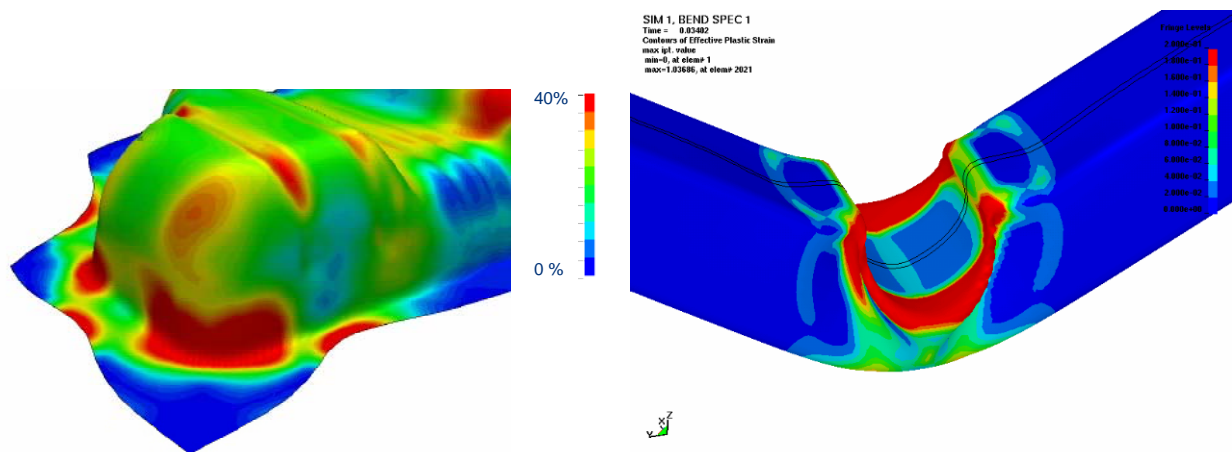

Figure 2: Simulated martensite volume

Figure 3: Simulated 3-point bending sample

Tooling

Stainless steels can in general be formed and worked by conventional processes. It is however important to remember the work hardening effects during processing which result in similar recommendations as those for high strength carbon or multiphase steels. These are of course the consideration of the higher punch- and blankholder-forces, necessary modifications of the draw bead restraining force, the use of more efficient tool material and coatings especially in critical areas as well as an optimized lubrication.

In the experiments for piercing and trimming the stainless steels 1.4376 and 1.4318 C1000 were compared. The used tool material was X70CrMoV5-2 (“Caldie”). Three different coatings, TiAlN, AlCrN, TiC were compared. Coatings were approved when at least 100.000 holes can be pierced without any burr height exceeding 60 μm and without any fatigue cracks or chipping tendencies present in the punches. For the TiC and TiAlN coatings the burr height when piercing 1.4376 is 25 μm in average. The punch force amounts to 30 N, the punch work increased during the test from around 18 J up to 20 J. Only in spalling differences between the two coatings could be observed. TiAlN did not show any signs of spalling whereas TiC showed spalling at the punch edges. Figure 4 shows the piercings at the beginning and after 100.000 strokes. Additionally, the punches after 100.000 strokes are depicted. These results show that it exists combinations of tool material/tool coating/lubricant that enable to pierce and trim stainless TRIP steels grades (fulfilling the demands from the automotive industry).

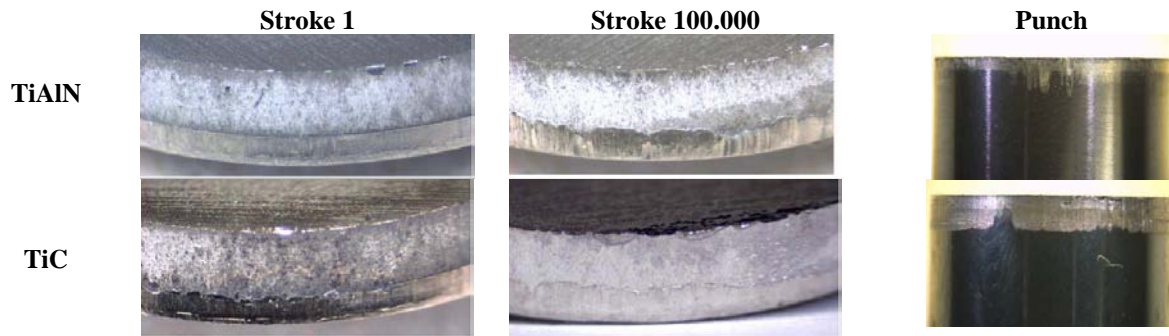

Figure 4: Comparison of piercings at the beginning and after 100.000 strokes

Joining

Stainless steels can be joined to each other as well as other materials with most common joining methods. To some extent deviations in parameters compared to what is common for mild carbon steels are inevitable. Main issue about joining stainless steels are the different physical properties compared to carbon steels that lead to different parameters compared to other steels or alloys (Table 4). Beside stainless-stainless combinations, emphasis was laid on the exploration of mixed combinations.

Table 4: Physical properties of stainless steels and other alloys

Grade	Thermal conductivity at 20°C $W * m^{-1} * K^{-1}$	Spec. electrical resistance at 20°C $\Omega * mm^2 / m$	Thermal expansion in 10 ⁻⁶ K ⁻¹ between 20°C and 100°C
DC03 (ferritic deep drawing C-steel)	50	0,22	12,0
DX54D (ferritic deep drawing C-steel)			
1.4310 1.4376	15	0,73	16,0
Ecodal 6181 (AlMgSi 0.8 alloy)	≥ 190	0,033	23,4

Altogether five different processes were covered experimentally. These were resistance spot welding for stainless-stainless and mixed combinations in two and three sheet joining, resistance spot welding with an additional adhesive bonding, laser welding, MAG-welding, and adhesive bonding. After joining, the different combinations were tested in cyclic tests, the bonded samples in shear and peel-tests. Welded joints were additionally tested in corrosive environments which will be discussed in the next chapter. Due to the large experimental part, only some exemplary results can be depicted in this manuscript.

Figure 5 shows the results for fatigue testing of spot welded and spot welded samples with additional bonding. The adhesive used is Betamate 1496, which is a one component, epoxy based adhesive manufactured by Dow Automotive. The additional bonding leads to a large rise in the measured loads amplitudes, both, for stainless-stainless joints and for the mixed joint of 1.4376-DC03+ZE. The same tendency could be observed for the other combinations investigated.

Resistance spot welding

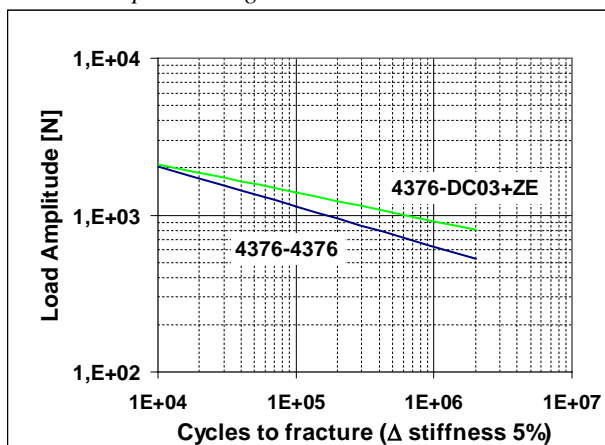

Resistance spot welding + bonding

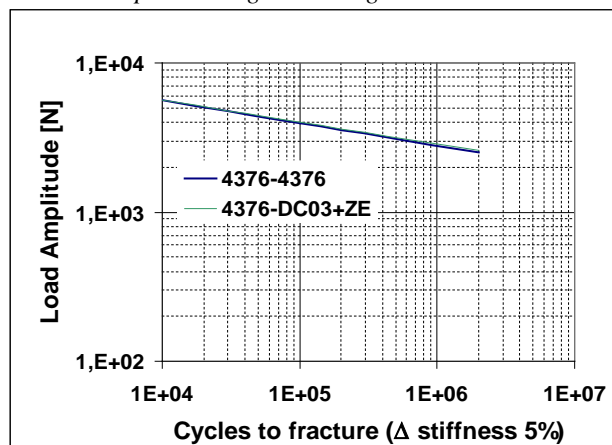

Figure 5: Comparison of fatigue tests of spot welded and spot welded + bonded samples Graph for 50% -Break down probability, $R=0,1$ / $f=90$ Hz / $T=25^{\circ}\text{C}$

Tailor welded blanking is an interesting method for optimizing components in regards of function as well as weight. Stainless steel can readily be used for that purpose in combination with other stainless steels or even with carbon steels which works with very good results as can be seen in Figure 6. Important factors to consider in laser welding are the laser power, the welding speed, the intensity of allocation, the focus diameter, the edge quality and positioning and the gas distribution.



H400-H400

HXT600X+Z-1.4318c

1.4318C1000 - DP600ZE

Figure 6: Micrographs of stainless-stainless and mixed laser weld, tailor welded blank

The most significant overall statements of the joining investigations were that stainless steels are weldable to each other and in mixed material joints. When employing resistance spot welding a higher electrode force might be necessary. MAG welding is suitable as well, but as for coated carbon steels, joints of stainless and coated carbon steels may show porosities. In laser-welding attention should be paid to the clampings and evaporation of zinc in dissimilar joints. The bonded joints show good values in shear and peel test.

Surface and Corrosion

Due to the passive layer stainless steels are resistant to humid atmosphere and to pure water, keep a bright shiny and stainless surface, and do not show rust as unalloyed steels and iron do. Generally, corrosion does only occur in very aggressive media (strong acids or hot strong alkalis) where the surface oxide film is not stable anymore. More relevant for daily life applications are forms of localized corrosion such as pitting and crevice corrosion. Stress corrosion cracking which can develop under very specific conditions included the effect of media bearing chloride ions. Consequently, the surface and corrosion part will primarily deal with forms of localized corrosion which may become relevant for automotive applications of stainless steels. In addition, strategies for avoiding galvanic corrosion when pairing stainless steels with less noble materials are discussed.

Especially after resistance spot welding the joint may be affected by localized corrosion and stress corrosion cracking. To avoid corrosion of the joints the seam can be protected by wax, by coatings which provide a cathodic protection, or in case of the spot welds with adhesive bonding by the adhesive, **Figure 7**.



Figure 7: RSW not protected with rust formation, and RSW which are protected by the bonding after salt spray test

Implementation of knowledge gained in B-pillar concepts

One major aim of the project was to transfer the knowledge gained as fast as possible to a new product development. Therefore each car manufacturer developed a B-pillar design as a mixed material concept. The concepts differed in terms of material choice, forming procedure and joining techniques, Table 5.

All of the concepts investigated lead to a decrease of weight compared to the reference concept which is fully made of carbon and multiphase steel. To check the cost efficiency of the newly developed concepts a calculation of costs was done. Based on the parameters of the ULSAB-study a calculation tool was developed which allows a closer view on the costs of the different processes, materials and joining techniques. Assuming that the maximum scrap volume does not exceed 40% of the initial blank size, concept C and E come already close to the reference concept.

Table 5: B-Pillar concepts of the NGV project

B-Pillar	Reference	C	E
Material	Rephos DP600	Rephos 1.4310-C 1000 + DP 600	Rephos 1.4310-C 1000 + DP600
Process	Tailor weld	Tailor weld	Rollform
Δ Wght	-	- 3.51 kg	- 4.81 kg
Δ Cost/ Δ Wght		4,40 €	0,40 €

To compile the results from the different work packages, two B-pillars (concept Hydroforming and Concept Stamping with tailor welded blanks) were on the one hand virtually designed which includes the forming simulation of e.g. the hydroformed parts, the mapping of results for the crash simulation and the crash simulation itself (Figure 8). On the other hand they were produced and crash-tested. A comparison of acceleration as function of time showed a good matching of the calculated level with the experimental results. The analysis of the maximum displacement revealed, that the simulation underestimates the intrusion which might be due to an overestimation of calculated strength. Nevertheless, the results show that a continuous simulation is possible and already comes to reasonable results. In the future the underlying models should be further adapted to optimise the simulated results.

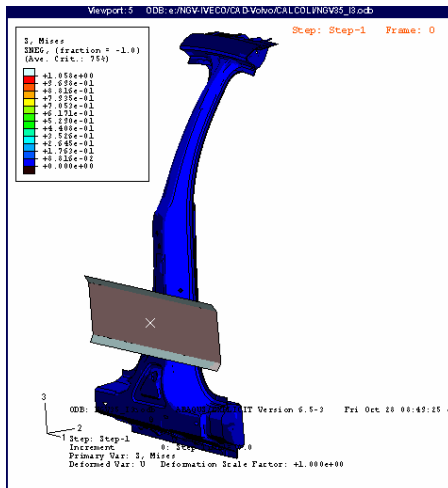

Figure 8: Model for crash-simulation



Figure 9: B-pillar for experimental crash-test

Conclusions

- Stainless steels show very good combinations of strength and ductility which is of special interest in automotive applications. The use of this materials presuppose the safe and correct use in all stages automotive development and production.
- In virtual development, the description of the material behaviour could be improved by the implementation of temperature sensitive models which allow the prediction of martensite and thus a more accurate strength determination in the virtual modelling.
- In tooling and forming stainless steels show the same restrictions as high-strength carbon steels do. Coatings such as TiAlN withstand the high forces and allow an accurate forming.
- Joining of stainless steels in uni-material and mixed joints is possible. In some cases deviations in parameters compared to what is common for mild carbon steels are inevitable but in general not greater than for different grades of carbon steel.
- To avoid corrosion of the joints the seam can be protected by wax, by coatings which provide a cathodic protection, or in case of the spot welds with adhesive bonding by the adhesive to ensure a continuity of the corrosion resistance.
- The implementation of the results into the design of several B-pillar concepts shows on the one hand the potentials for a further weight reduction and on the other hand the cost efficiency of some concepts. Designing with stainless steel need not necessarily to be adversarial compared to mild and multiphase steels especially in terms of weight savings and by the same time reasonable costs.

References

- [1] A. H. C. Hänsel, P. Hora, and J. Reissner, "Model for the kinetics of strain-induced martensitic phase transformation at non-isothermal conditions for the simulation of sheet metal forming processes with metastable austenitic steels", Simulation of Materials Processing: Theory, Methods, and Applications, Huétink and Baaijens (eds), Balkema, Rotterdam, 1998
- [2] P.-O. Santacreu, J.C. Glez, N. Roulet, T. Fröhlich, Y. Grosbety, Austenitic Stainless Steels For Automotive Structural Parts, SAE papers 2006-01-1215
- [3] Stahl-Eisen-Prüfblatt (SEP) 1240: Prüf- und Dokumentationsrichtlinie für die experimentelle Ermittlung mechanischer Kennwerte von Feiblechen aus Stahl für die CAE-Berechnung

DESIGN OF A STAINLESS B-PILLAR – A CONCEPT EVALUATION USING FINITE ELEMENT SIMULATION

E. Schedin^①, M. Jansson^②, H. L. Groth^①, P-O. Santacreu^③ and E. Ratte^④

^① Outokumpu Stainless
Avesta Research Centre
774 22 Avesta, Sweden
e-Mail: erik.schedin@outokumpu.com
Web page: <http://www.outokumpu.com/stainless>

^② Engineering Research Nordic AB
Garnisonen Brigadgatan 16
SE-581 31 Linköping, Sweden
e-mail: mikael@erab.se
Web page: <http://www.erab.se>

^③ Arcelor Mittal Stainless
Isbergues, France
e-mail: pierre-olivier.santacreu@arcelormittal.com
Web page: <http://www.arcelormittal.com>

^④ ThyssenKrupp Nirosta GmbH
Oberschlesienstrasse 16
47807 Krefeld, Germany
e-mail: evelin.ratte@thyssenkrupp.com
Web page: <http://www.nirosta.de>

Keywords: Forming, Crash, Simulation, Stainless Steel, Transformation Induced Plasticity

ABSTRACT. *Since stainless TRIP steel grades have a potential for a large TRIP-effect, which is temperature dependent, it is necessary to introduce a thermo-mechanical component in forming simulations. The TRIP-effect obviously has a great impact on the forming behavior of the steel grades in general but also, on the resulting strength after forming a component. Consequently a new strategy for simulation, together with more sophisticated material models in the software, have to be used to ensure correct results for stainless TRIP steel grades. The forming simulation also needs to provide a forming "history" containing information about the resulting strength distribution from fabrication, thereby providing a correct base for crash simulation. This paper compares forming and crash simulations of two different stainless steel intensive B-pillars with experimental results.*

1. INTRODUCTION

Stainless TRIP steel grades provide a combination of strength and formability, hardly met by any other commercial steel grades. In order to fully utilize this effect in design of fabrication processes in general, and specifically to design ultra high strength components, it is necessary to develop simulation tools for the different fabrication steps and the final use of the component. Such tools would also be valuable to optimize component properties through a distribution of strength over the structure.

This paper addresses the fact that the forming of an automotive component increases the strength and thereby also affects the crash performance. For a stainless TRIP-steel this effect can be so high that neglecting it would make the prediction of the crash performance more or less meaningless.

The transformation induced phase transformation, or TRIP-effect, is temperature dependent, which makes thermo-mechanical simulations necessary. In this work, the simulation approach for the forming process is based on the Hänsel model [1] and has been described in other publications [2,3]. The crash response is then included after mapping the forming result to the crash simulation. LS-DYNA version 971 was used for all simulations. The outcome of two B-pillar concepts is presented, one with a deep drawn reinforcement from a tailor-welded blank and one with a stainless reinforcement hydroformed from a conical tube.

2. MATERIALS

Three high strength stainless TRIP steel grades were included with chemical composition according to **Table 1** and mechanical properties according to **Table 2**. 1.4318 C1000 was used in the temper rolled condition, i.e. the final cold rolling reduction has not been followed by an annealing treatment. 1.4310 and 1.4376 on the other hand were used in the soft annealed condition.

Table 1 Typical chemical composition of included stainless steel grades

Grade	C	N	Cr	Ni	Mn
1.4318 C1000	0.025	0.11	17.5	6.6	<2.0
1.4310	0.10	0.03	17.0	7.0	<1.3
1.4376	0.03	0.19	17.6	4.2	6.5

Table 2 Typical mechanical properties of included stainless steel grades

Grade	R _{p0.2} (MPa)	R _m (MPa)	A ₈₀ (%)
1.4318 C1000	800	1050	18
1.4310	300	800	45
1.4376	410	740	40

The material choice demonstrates the two approaches to design high strength components with stainless TRIP steel, either to secure the lower strength level by starting with a high strength material (1.4318 C1000) or the more innovative way to start with a material in its soft condition and utilize the TRIP-effect to reach the design strength of the component (1.4310 and 1.4376).

Apart from the stainless steel grades, carbon steel grades DX56D, Rephos220 and DP600 were used to complete the respective B-pillar designs.

3. B-PILLAR CONCEPTS

3.1. The reference

As a reference the Volvo S40 B-pillar was chosen as shown in **Fig 1**. It consists of carbon steel grades with tensile strength ranging from 340 to 600 MPa and sheet thickness from 0.9 to 1.95 mm. The reference gave the geometric design restrictions for the stainless B-pillars and also, the target crash requirements.

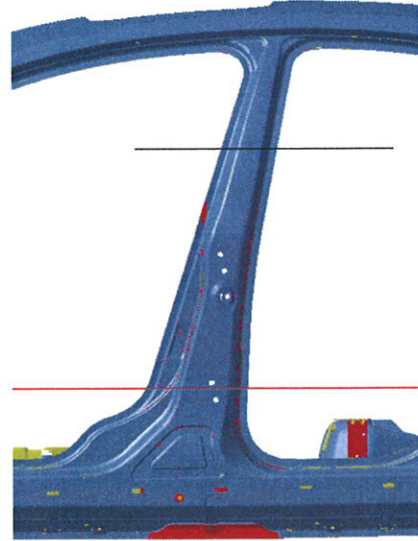

Fig 1 The reference Volvo S40 B-pillar

3.2. TW concept

The TW concept is a deep drawing concept, where the reinforcement is made of a tailor-welded blank between the stainless steel grade 1.4318 C1000, 1.85 mm thick and the dual phase steel DP600, 1.2 mm thick. The component is shown in **Fig 2**. The upper part of the tailor-welded blank is made of 1.4318 C1000 and the lower part of DP600.

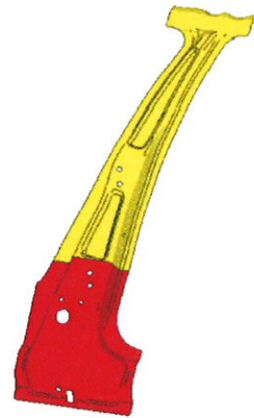

Fig 2 The tailor welded B-pillar reinforcement of the TW concept. The upper part is made of 1.4318 C1000, 1.85 mm thick, and the lower part of DP600, 1.2 mm thick.

3.3. Hydroformed concept

The stainless reinforcement was made by a conical tube of 1.4310, 2.0 mm thick that was hydroformed from its soft annealed condition to the design strength. The lower reinforcement was produced by deep drawing of the stainless steel grade 1.4376 with 1.2 mm thickness. **Fig 3** shows the stainless parts of the hydroformed concept.

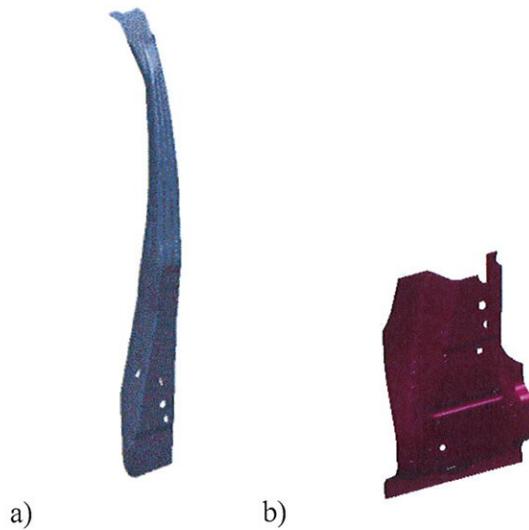

Fig 3 a) The B-pillar reinforcement of the hydroformed concept made of a conical tube of 1.4310, 2.0 mm thick. b) The lower reinforcement, deep drawn from 1.4376, 1.2 mm thick.

3.4. The complete design

The complete B-pillars were assembled with carbon steel parts as displayed in **Fig 4** for the TW concept. The weight saving of the respective stainless intensive concepts was about 9% for the TW concept and about 11% for the hydroformed concept.

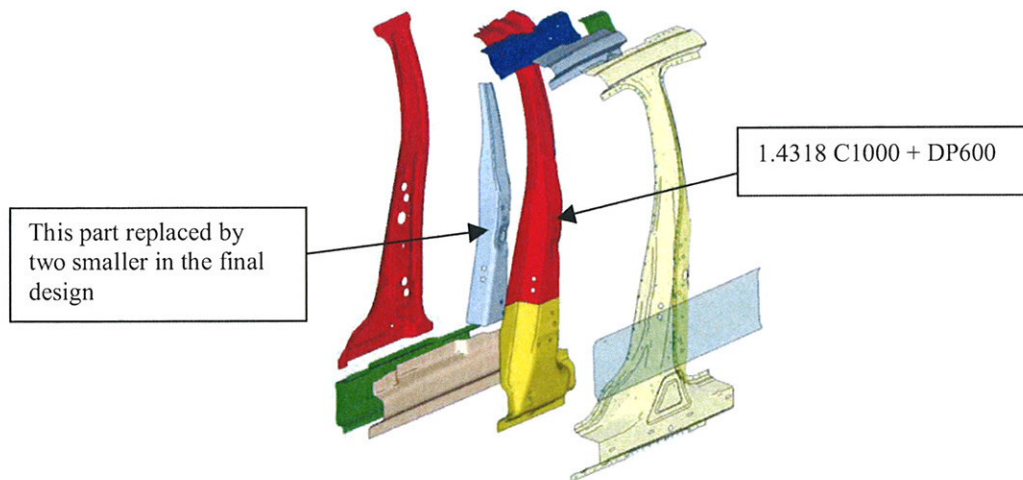

Fig 4 The final assembly of the TW concept

4. EXPERIMENTAL PROCEDURE

Only the stainless parts were produced and analyzed within this work. The carbon steel parts were taken from the normal production of the reference B-pillar.

4.1. Forming of the TW concept

Hard tooling for deep drawing was produced for the TW blank. The tool was produced with a normal simulation procedure without taking the TRIP-effect into consideration. The resulting die was possible to use for prototype manufacturing with only minor adjustments.

4.2. Forming of the hydroformed concept

The hydroforming process was designed through extensive thermo-mechanical simulations including the TRIP effect. The resulting tubular blank is shown in **Fig 5**. Also in this case, hard tooling was produced. Some adjustments had to be made during die tryout, but in general, prototype manufacturing was straight-forward from the as-simulated die.

The lower reinforcement was produced in a deep drawing process utilizing hard tooling.

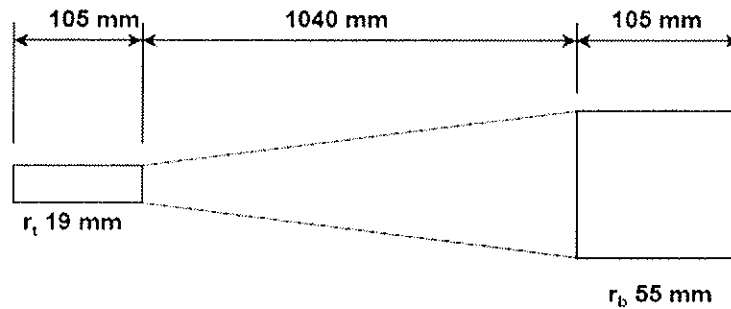

Fig 5 The tubular blank for the hydroformed concept

4.3. Determination of the proof stress distribution after forming

A very important aspect of stainless TRIP steel grades is the potential to increase its strength during forming. The proof stress distribution after forming was estimated by hardness measurements along the same line as the strain distribution. The hardness values translated to the corresponding tensile strength value through the left diagram in **Fig 6**. The proof stress value was then determined by the curve in the right diagram.

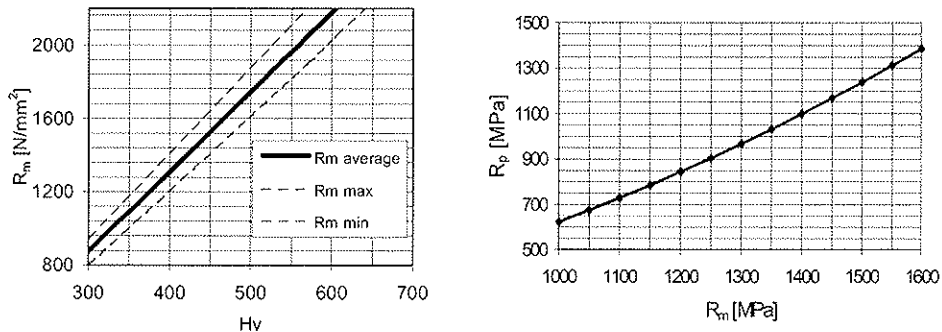

Fig 6 Translation of the hardness values to proof stress

4.4. Crash test

Normally, a single B-pillar is not crash tested by the automotive industry, but rather complete vehicles with a standardized side impact procedure. It is therefore not possible to refer to some standardized procedure or values for a single B-pillar. In the present work, this problem was solved by manufacturing reference B-pillars from a Volvo S40 structure and crash test these to give reference values for the two new stainless steel intensive concepts. The crash test rig and the resulting component geometry after testing is shown in **Fig 7**. A 230 kg heavy rounded-square cylinder at 25.8 km/s impacts the B-pillar. After several trials to set the boundary conditions in order to resemble the complete vehicle, it was decided to fix the upper part and the lower part.

The comparison between the reference B-pillar and the stainless concepts will not be discussed further here since it is not the scope of the paper. It can be mentioned however, that both concepts had approved crash performance compared to the reference, with the TW concept being slightly better than the hydroformed concept.



Fig 7 The crash test rig and the resulting component geometry after testing

5. SIMULATION RESULTS

5.1. The TW concept

After forming, the strain distribution was analyzed in two areas, as displayed in **Fig 8**. Area A is in the carbon steel sheet and area B is in the stainless steel sheet. In area B, the sheet thickness, the martensite content and the hardness profile were also determined. The simulations started with a verification of the draw bead restraining forces by comparing the calculated and experimental flange reduction. As can be seen in **Fig 9** and **Fig 10**, the calculated strain distribution corresponds well to that determined experimentally. The deviations are found primarily in the peak values, which rather reflect the experimental limitations, with a too coarse strain measurement grid to resolve the strain level in sharp radii than errors in calculations.

Most important for this work is the very good prediction of the component strength and sheet thickness in the stainless steel part in **Fig 10** since this will heavily influence the response of this part in the subsequent crash testing.

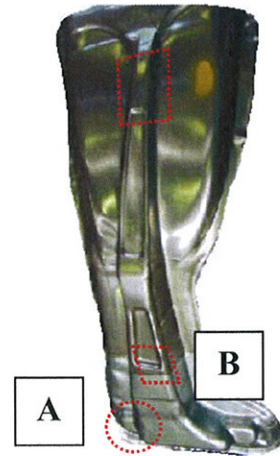

Fig 8 Analyzed areas for the TW concept

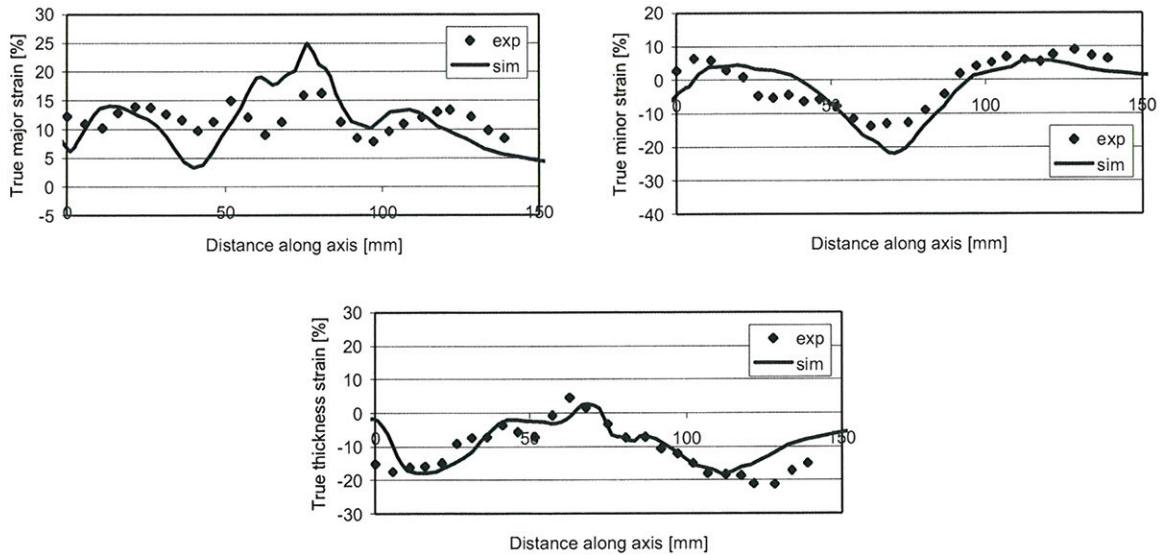

Fig 9 Comparison between experimental and calculated strain distributions in area A of the TW concept

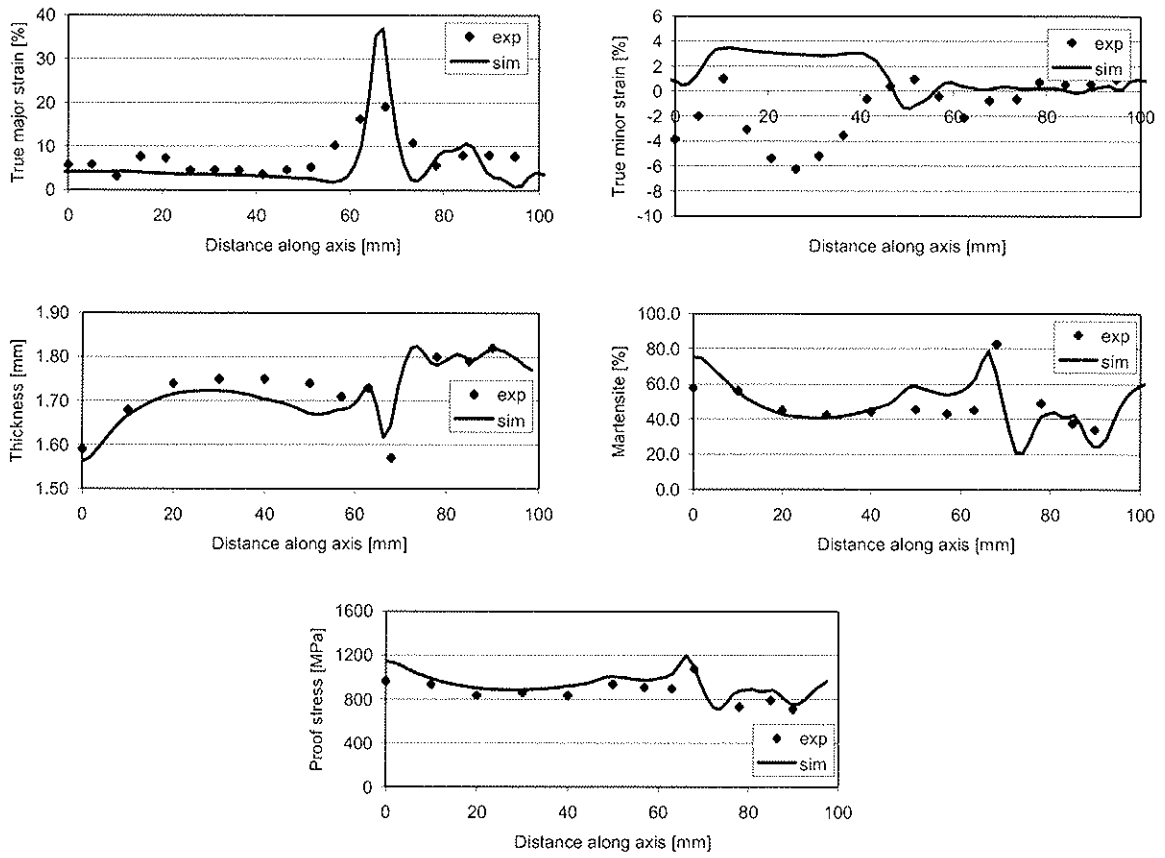

Fig 10 Comparison between experimental and calculated strain distributions, thickness, martensite content and derived proof stress in area B of the TW concept

Simulation of the crash test was performed by mapping the volume fraction of martensite, thickness distribution and plastic strain distribution of the complete tailor welded blank, to the crash model. The other carbon steel parts were treated as having the same properties as the as-received material. Further, the crash occurred in adiabatic conditions and the Hänsel model was used without strain rate sensitivity. The spotwelds were included in the model as deformable beam elements at the same positions as the actual assembly. Spotweld failures observed in the experiments were replicated in the simulations.

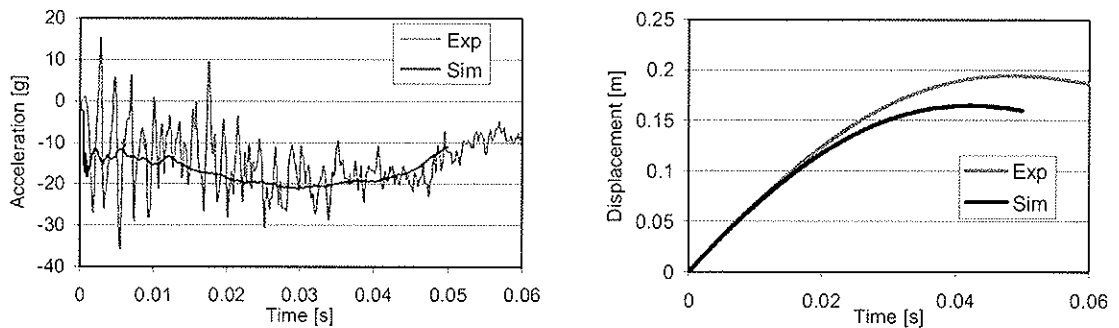

Fig 11 Comparison between experimental and calculated acceleration and penetration of the fully assembled B-pillar containing the stainless TW-concept. Evaluation was made at the position of the impactor

The results of crash testing the TW concept are displayed in **Fig 11**. As can be seen, the results indicate a good prediction of the acceleration, while the penetration is somewhat underestimated, or in other words, the B-pillar is predicted to be stiffer than in the experiments.

5.2. The hydroformed concept

The hydroformed tube was cut into four pieces in order to be able to determine the thickness and hardness distribution in these sections, see **Fig 12**.

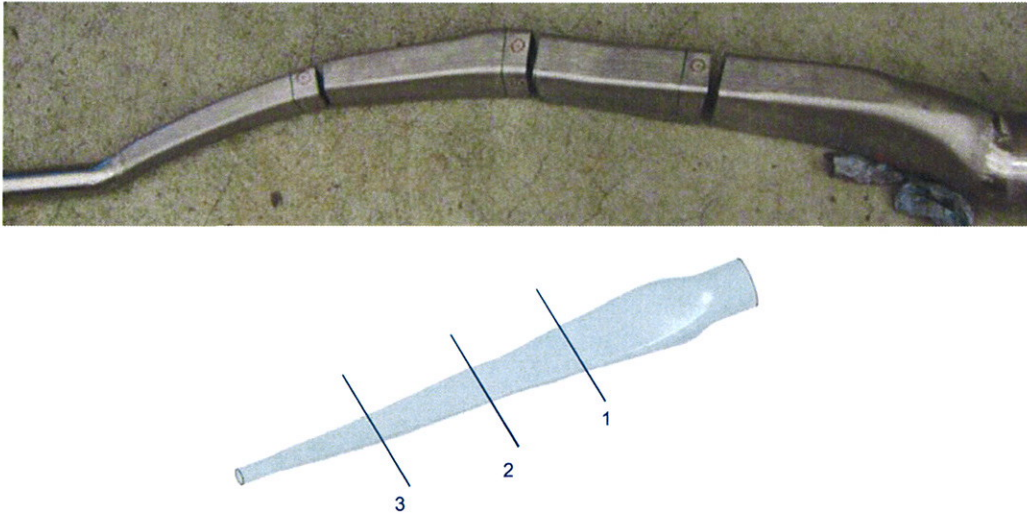

Fig 12 The hydroformed tube was cut into four pieces for evaluation of thickness and hardness. The lower picture shows the notation of the sections

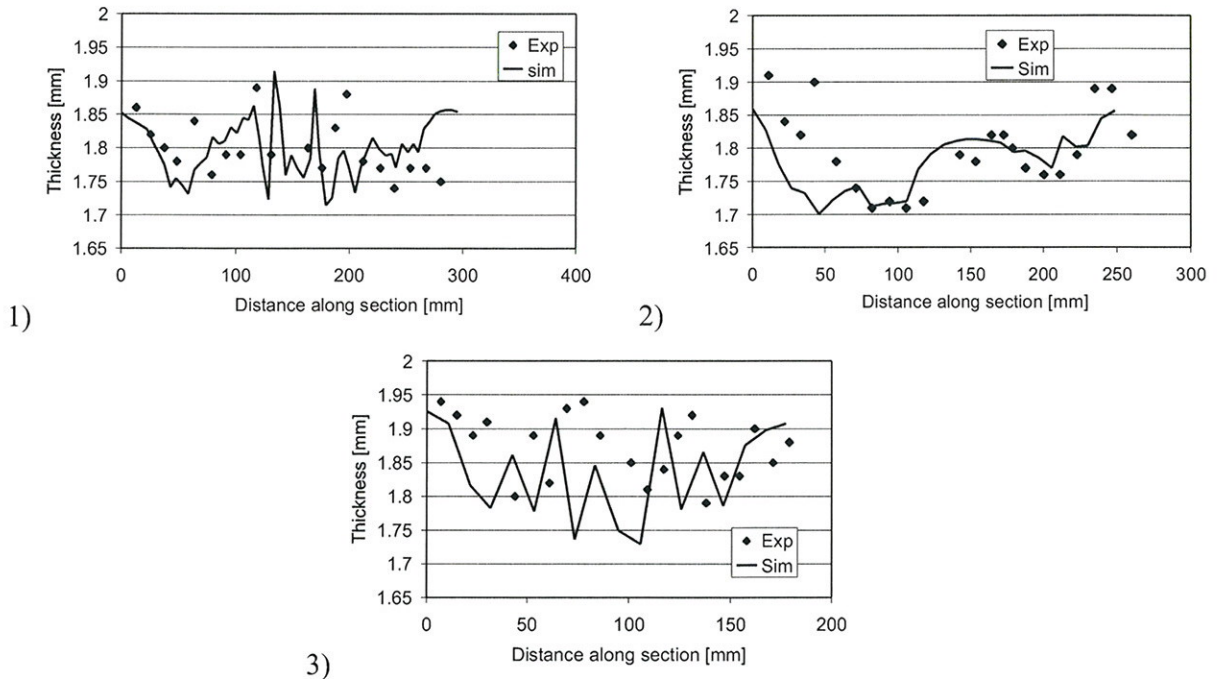

Fig 13 Comparison between experimental and calculated thickness distributions in area 1, 2 and 3 in Fig 12.

The calculated thickness distributions in **Fig 13** correlate well with the experimental values, even though the frequency of maxima and minima does not exactly coincide. This is both due to problems to locate exactly the same evaluation areas in experiments and calculations and to limited accuracy in the experimental data.

Hardness measurements were performed in some critical areas distributed over the hydroformed tube. In **Fig 14** some data from radii are reported from the same sections as in **Fig 13**. Evidently, the calculated proof stress level is overestimated up to a level of 340 MPa in area 3.3. In flat areas on the other hand (not shown here), the calculated proof stress compared well with the experimental data.

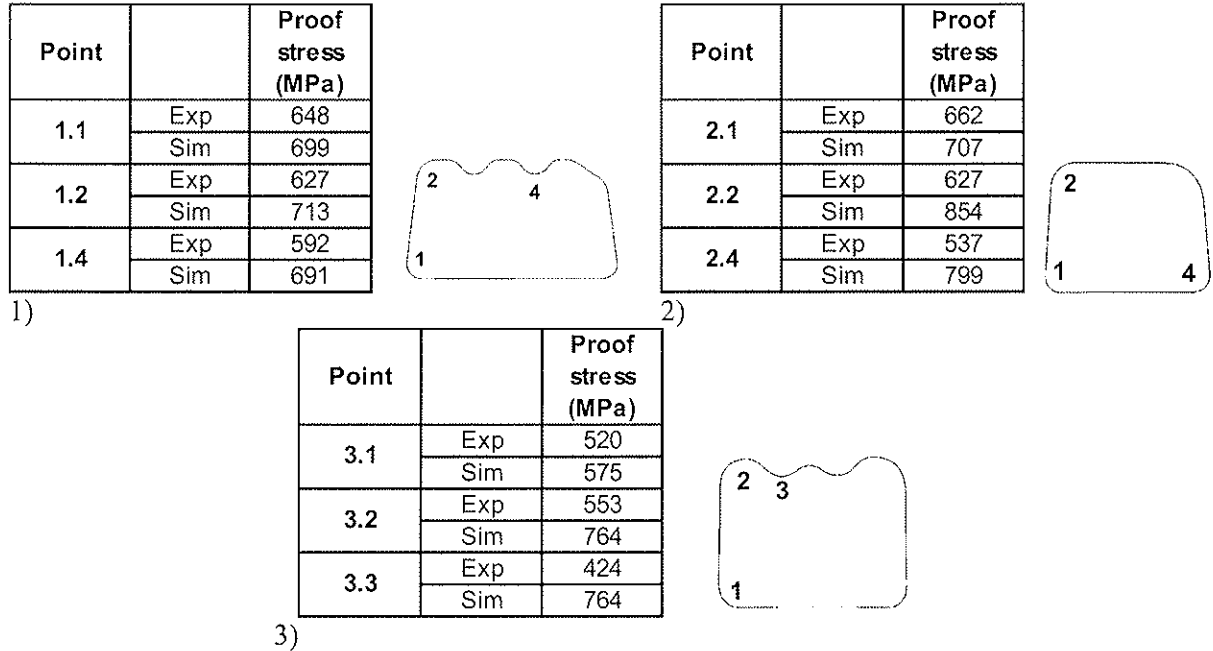

Fig 14 Comparison between experimental and calculated proof stress level in selected areas along the sections 1, 2 and 3 in **Fig 12**.

Simulation of the crash test was performed by mapping the volume fraction of martensite, thickness distribution and plastic strain distribution of the hydroformed tube to the crash model. The carbon steel parts were treated as having the same properties as the as-received material. Further, the crash occurred in adiabatic conditions and the Hänsel model was used without strain rate sensitivity. The spotwelds were included in the model as deformable beam elements at the same positions as the actual assembly. No spotweld failure was found in the actual crash tests.

The results of crash testing the hydroformed concept are displayed in **Fig 15**. As can be seen, the results indicate a good prediction of the acceleration, while the penetration is somewhat underestimated, or in other words, the B-pillar is predicted to be stiffer than in the experiments.

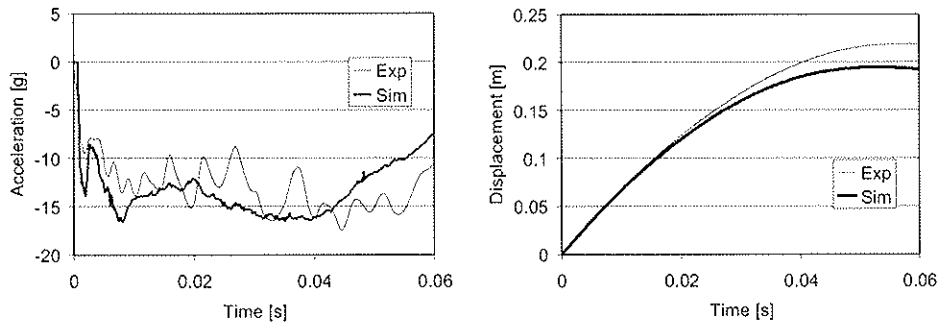

Fig 15 Comparison between experimental and calculated acceleration and penetration of the fully assembled B-pillar containing the stainless hydroformed concept. Evaluation was made at the position of the impactor.

6. DISCUSSION

The TW concept in this work verifies previous investigations in [2,3] and other unpublished work that it is possible to predict the forming behavior of stainless TRIP steel grades with good accuracy in deep drawing operations. In this work, hydroforming was added and some problems to predict the as-formed strength level were observed. Through a set of separate hydroforming experiments in another more simple geometry, a plausible explanation was found in terms of the way temperature is predicted. In hydroforming it is very important to establish the exact cycle time and the timing for tool contact in order to calculate correctly the sheet temperature. Another unknown factor is the cooling effect from the water used. Most probably, the hydroforming cycle time and the cooling effect from the water used were overestimated in these simulations, both giving too low a temperature in the sheet and thereby too high a proof stress level, despite the good prediction of thinning.

In spite of the rather good prediction of proof stress level of the formed stainless reinforcements, the stiffness of the complete B-pillars was overestimated, so the calculated intrusion level was too low for both concepts. Due to the complexity of these simulations, many potential sources of errors can be proposed. However, the aim of the present work was to demonstrate how the crash performance of stainless TRIP steel grades can be predicted, rather than to deeply analyze the accuracy in experimental and simulation crash techniques.

In order search for potential systematic errors in simulations or experiments, it was therefore decided to simulate the reference Volvo S40 B-pillar in exactly the same FE-model as used for the stainless concepts, with the exception that only carbon steel components were used with as-received material properties. The result shown in **Table 3**, was that the calculated intrusion is underestimated also for the reference B-pillar, indicating a systematic error in the crash simulations or experiments.

Table 3 Comparison of the calculated and experimental maximum intrusion

	Calculated intrusion (mm)	Experimental intrusion (mm)	Error (mm)
Reference	151	192	-41
TW concept	165	194	-29
hydroformed concept	194	215	-21

However, the relative ranking of the reference and the stainless intensive concepts is the same in experiments and simulations as can be seen in **Table 3** where the maximum intrusion is compared. In fact, the largest error is found for the reference, which probably could have been reduced by inclusion of spot weld failures.

The conclusion to be drawn from this exercise is that the crash responses of the stainless intensive B-pillar concepts are predicted as well as the reference carbon steel concept. It should also be noted, that even if the intrusion does not correlate well, the overall deformation of the stainless B-pillars did correspond well with the experiments.

And also, the crash response of both stainless B-pillar concepts was approved by the automotive partners and were found interesting to continue working with.

7. CONCLUSIONS

The complexity of the present B-pillars makes the comparisons between experiments and simulations difficult, particularly since there are several potential sources of errors, both in simulations and experiments. However, the general conclusion is that it is possible to simulate both forming and crash of stainless TRIP steel grades with reasonable accuracy. This conclusion is not only based on the present work but also on experiences gained from other published and unpublished work. It is also clear that certain improvements are necessary, especially when it comes to thermal predictions.

8. ACKNOWLEDGEMENTS

This work was performed within the joint project "Next Generation Vehicle". The project was organized by the three stainless steel producers Outokumpu Oyj, ArcelorMittal Stainless and ThyssenKrupp Nirosta GmbH together with AUDI AG, BMW AG, Daimler AG, Saab Automobile AB/General Motors, Volvo Cars/Ford and the Centro Ricerche Fiat. Visit the project homepage for more information [4].

Press forming, assembly and strain measurements of the TW-concept were performed by CRF under supervision of Michele Immarino, while Rita Lindström and Annika Talus at Avesta Research Centre performed the detailed martensite and hardness evaluation. The hydroforming experiments were supervised by Jan Starck at AP&T and the experimental evaluation by IDC in Olofström under supervision of Per Thilderkvist. Crash tests were performed at Daimler AG under supervision of Marcus Feucht.

9. REFERENCES

1. A. H. C. Hänsel, P. Hora, and J. Reissner, "Model for the kinetics of strain-induced martensitic phase transformation at non-isothermal conditions for the simulation of sheet metal forming processes with metastable austenitic steels", *Simulation of Materials Processing: Theory, Methods, and Applications*, Huétink and Baaijens (eds), Balkema, Rotterdam, 1998
2. Schedin E, Prentzas L and Hilding D, Finite Element Simulation of the TRIP-effect in Austenitic Stainless Steel, *SAE World Congress 2004*, paper 2004-01-0885.
3. Schedin E. and Kajberg J., Real Behavior and FEA Modeling of Stainless Steels, Proc of FLC Zurich 2006, *Numerical and experimental methods in prediction of forming limits in sheet forming and tube hydroforming processes*, p 98-103.
4. <http://www.ngvproject.org/>

Fuel cells offer opportunity for stainless

Both proton exchange membrane (PEM) and solid-oxide fuel cell (SOFC) types present new opportunities for stainless steel (SS)—for example in heat exchangers, humidifiers, combustors, and plates.

“All of those different components could be made up of metallic materials, and very often stainless steel represents the best optimal point between costs and performance,” said Scott Weil, a staff scientist with expertise in materials science and metallurgy at the **Pacific Northwest National Laboratory**, which has worked with companies (such as **Delphi** on its SOFC) to overcome issues on a technology’s path to production.

A SOFC stack consists of two major components: the membrane, which usually is made of a ceramic, and an interconnect plate, which serves to connect one membrane to another electrically.

“When the electrochemical reaction occurs you get as a by-product water,” Weil explained. “So that’s another thing you have to be concerned about is what’s the durability of the metal under those conditions—high-temperature air, high-temperature hydrogen, and a humid environment. Many stainless steels are very oxidation-resistant; that’s one of the big pluses.”

Another “big plus” with certain stainless steels, according to Weil, is that they offer good thermal-expansion matching with the ceramic material. “If you pick a metal that expands at a very high rate, you’ll have a chance of cracking your ceramic membranes.” In particular, the 400 series ferritic stainless steels work well in this role: “The austenitics are not as good a match,” he said.

Though stainless is the leading candidate for that SOFC plate application (nickel-based alloys and electrically conductive ceramic plates with perovskite materials have also been considered), it is not without its issues, Weil noted.

While SS is generally very oxidation-resistant, that resistance may not be sufficient by itself in the long term—after tens of thou-

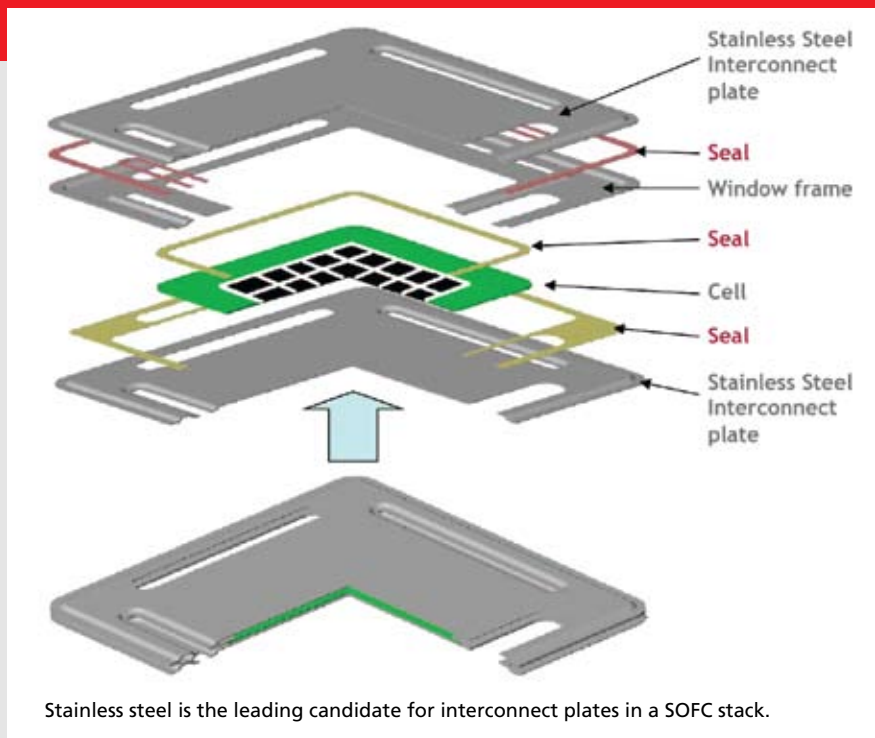

Stainless steel is the leading candidate for interconnect plates in a SOFC stack.

Pacific Northwest National Laboratory

sands of hours of use. “And [stainless] may not be as electrically conductive as you would like out at the long term as well,” he added. “So people have been looking at not necessarily replacing the stainless steel, but how to modify it to make it work better in that environment.”

One way, he noted, is by applying conductive oxide coatings such as manganese cobaltite, which can be sprayed and sintered onto the surface of the SS to form a tight, adherent layer.

The greatest competition among materials, according to Weil, is in the PEM fuel cell for the bipolar plate, which has typically been made of graphite because it’s very corrosion-resistant and electrically conductive.

“The problem is that graphite is brittle, so it’s not something you necessarily want to put in a device that’s in a transportation vehicle,” he said, adding that graphite is also expensive, not to mention time-consuming and costly to machine

for channels that transport water and gas.

Alternative materials considered include carbon composites, conductive polymers, and various metals such as nickel, titanium, and both austenitic and ferritic SS. “Each of those materials has its pluses and minuses,” said Weil. “Stainless steel is certainly in the running, again because it’s probably the lowest-cost material that you can consider for that application, because you can make it very thin, and because you can manufacture it by stamping or by coining processes to get those gas passages built into it; you don’t have to machine it. So it often offers lower-cost manufacturability.”

Stainless may also have an edge because automotive designers and manufacturers are already comfortable using steels. “They’ve used them for decades,” he said.

Ryan Gehm

forming and 3-D profiling. Some grades less sensible to the fluctuation of alloying elements (Ni) could also be promoted and proposed.

“We know that if you put a few stainless parts at good places in a BIW it is cost-effective, but also we need time for homologation of new grades in the auto industry.”

Though a bonus to using SS is that it could remain uncoated and unpainted, applying those processes to stainless is not as simple as with other materials. “We need to have a rougher surface [than] the regular surface for stainless steel,” said Schuberth. “So we need to do some extra [surface preparation] so that the coat sticks.”

“We have looked into all different sorts of pretreatment of stainless to allow for surface treatment or complete painting,” Gustafsson said. “So there are paint systems available from the paint suppliers that are fully adapted for stainless or even the more difficult mixed-materials situation where you’ll have stainless together with zinc-plated steel or with aluminum.”

Gustafsson predicts that at least another three or four years will pass before a vehicle with a structure consisting significantly of unpainted SS parts hits the market in either Europe or the U.S.

Just don’t expect it to be equipped with a flux capacitor, like that famous Hollywood-modified DeLorean. **aei**